

BLU - BLU EXTRA S

Wall-mounted gas condensing boilers



BLU
Indoor wall-mounted boiler
HEATING and instant DHW production



BLU EXTRA S
Outdoor wall-mounted boiler for HEATING only



HIGH PERFORMANCE
103.4% CERTIFIED



CLASS 6



20% H₂ READY



HEATING



DHW (BLU)

Technical and construction characteristics

BLU and BLU EXTRA S are compact condensing gas boilers with sealed chamber and forced draft.

BLU and BLU EXTRA S are simple to install and use, equipped with cutting-edge components and made to high quality standards which guarantee a product with an excellent level of reliability.

The advanced electronics are easily managed through the intuitive control panel with backlit display or via the remote control to be chosen as an accessory for the BLU indoor models (standard for the BLU EXTRA S 32 model).

The integrated management system promptly analyzes combustion at all times, guaranteeing the best performance in terms of efficiency (class A which becomes A+ with the use of the remote control in class 5) and polluting emissions (class 6 NO_x). All models are equipped with electronic ignition and ionization flame control. Furthermore, the advanced management system allows conversion to LPG by acting only on the parameters without the need for additional conversion kits.

The BLU and BLU EXTRA S boilers are already set up for operation with a mixture of methane and hydrogen gas (20%). A2B Accorroni offers a wide range of accessories that allows for easy application of these boilers.

BLUE version

The BLU boiler is designed for installation inside rooms or in a partially protected place for the production of heating and instant domestic hot water.

It is available in the powers 20 - 24 - 28 - 32 - 34 kW.

The production of domestic hot water is carried out via an instantaneous plate exchanger (n. 10 plates in the 20 kW power, n. 14 plates in the 24 and 28 kW power and n. 16 plates in the 32 and 34 kW power) which allows to offer an increase in power up to kW in DHW production.

The ultra-compact dimensions allow the possibility of insertion even in a built-in wardrobe, usable even in the thinnest walls.

EXTRA S BLUE version

The BLU EXTRA S boiler is designed for outdoor installation, directly exposed to atmospheric agents for the production of heating with the possibility of combining it with a separate DHW tank. It is available in 32 kW power.

The BLU EXTRA S boiler is certified with IPX5D protection rating and is supplied with a special casing and the fume exhaust accessory which guarantee waterproofness even in the event of heavy rain.













The BLU EXTRA S boiler is supplied as standard complete with a lower cover to protect the hydraulic connections and a remote control that allows the control and regulation of the boiler inside the home.

Model	Thermal Power kW*	Thermal flow kW	Code	€
BLU 20 (heating and DHW)	21,0	20,0	30420020	1.740,00
BLU 24 (heating and DHW)	24,9	24,0	30420021	1.850,00
BLU 28 (heating and DHW)	30,6	28,0	30420022	1.980,00
BLU 32 (heating and DHW)	35,1	32,0	30420023	2.060,00
BLU 34 (heating and DHW)	36,1	34,5	30420034	2.160,00
BLU EXTRA S 32 (heating)	35,1	32,0	30400032	2.490,00

*Heating thermal power (50-30 °C)











BLU - BLU EXTRA S

Wall-mounted gas condensing boilers

Accessories BLU 20 - 24 - 28 - 32 - 34 - BLU EXTRA S 32		Code	€
	Standard command and remote control panel (standard for the BLU EXTRA S)	30400034	106,00
	Advanced remote control	30403110	220,00
	Remote management kit (Wi-Fi) to be combined with the standard remote control or to the advanced remote control	30403113	364,00
	Domestic hot water tank temperature probe (only for BLU EXTRA S)	30403115	20,00
	External probe	30403109	26,00
	Zone management card (high and low)	30403132	218,00
	Bracket for wall installation	30403133	16,00
	Fitting cover kit	30403134	60,00
	Hydraulic and gas fitting kit	30403135	38,00
	Antifreeze resistance kit	30403114	316,00
	Polyphosphate dispenser	30403136	126,00
	Adjustable semi-automatic self-cleaning magnetic dirt separator for vertical and horizontal installations with 3/4" connections	30403131	396,00
	Built-in wardrobe	30403138	254,00

BLU - BLU EXTRA S

Wall-mounted gas condensing boilers

Accessories only for mod. BLU 20 - 24 - 28 - 32 - 34		Code	€
	Coaxial vertical outlet Ø 60/100 with smoke extraction	30403124	32,00
	Coaxial starting curve Ø 60/100 at 90° with smoke extraction	30403123	38,00
	Separate duct kits Ø 80/80 with smoke extraction	30403022	50,00
	Curve 90° Ø 80 M/F	30403013	8,00
	Curve 45° Ø 80 M/F	30403012	8,00
	Extension Ø 80 M/F = 1000 mm	30403011	10,00
	Curve 90° coaxial Ø 60/100 M/F	30403004	38,00
	Curve 45° coaxial Ø 60/100 M/F	30403003	30,00
	Coaxial extension Ø 60/100 M/F = 1000 mm	30403002	28,00
	Coaxial fume exhaust kit Ø 60/100	30403000	60,00
	Coaxial roof terminal Ø 60/100	30403014	144,00

Dimensions BLU 20 - 24 - 28 - 32 - 34

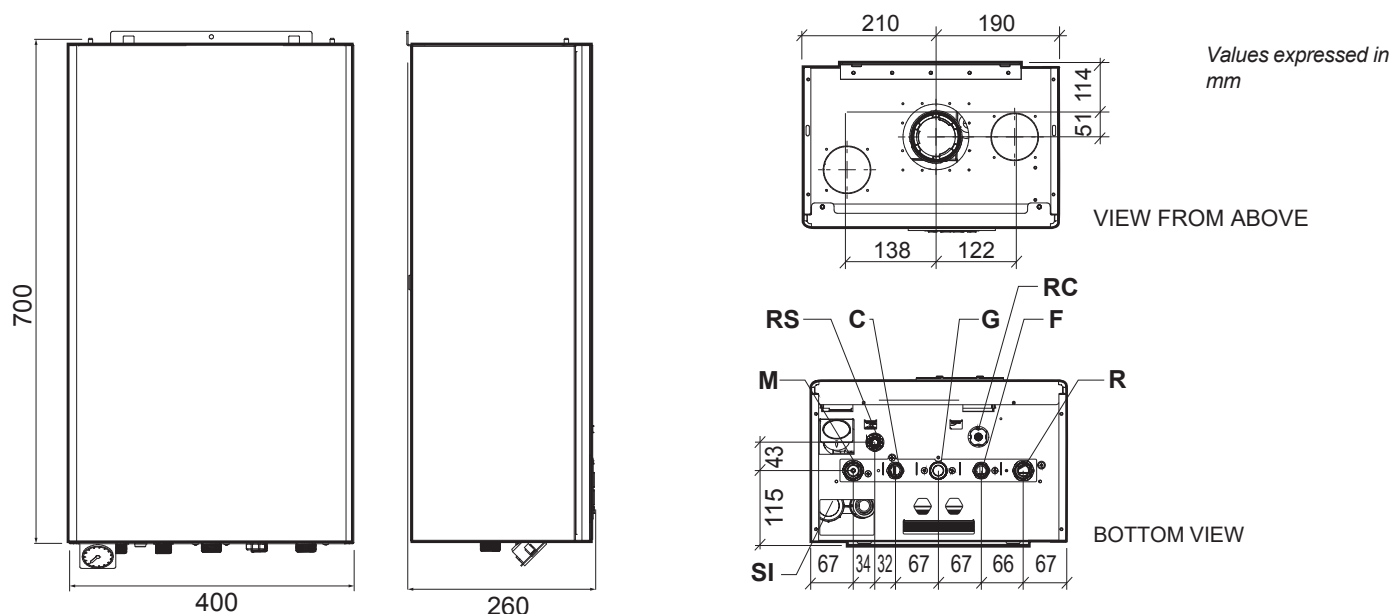

F Cold water inlet (1/2")
 G Gas inlet (3/4")
 SI Siphon inspection cap
 M Heating system flow (3/4")

C Domestic hot water outlet (1/2")
 R Heating system return (3/4")
 RS Drain cock and safety valve drain
 RC Filling cock

BLU - BLU EXTRA S

Wall-mounted gas condensing boilers

Dimensions BLU EXTRA S 32

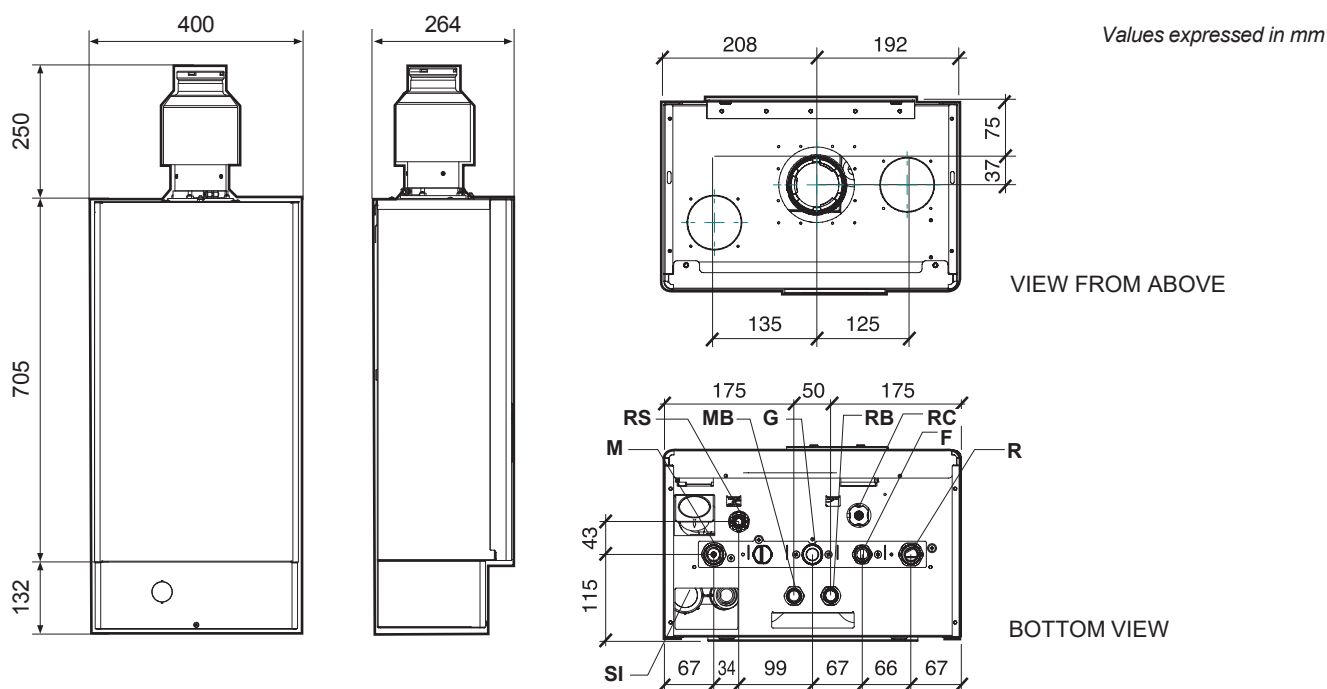

F Cold water inlet (1/2")
 G Gas inlet (3/4")
 SI Siphon inspection cap
 M Heating system flow (3/4")
 MB Secondary flow to the boiler (3/4")

RB Secondary return from the cylinder (3/4")
 R Heating system return (3/4")
 RS Drain cock and safety valve drain
 RC Filling cock

Boiler technical data table BLU 20 - 24 - 28 - 32 - 34

DESCRIPTION	U.M.	BLU 20	BLU 24	BLU 28	BLU 32	BLU 34
Device category		I12H3P	I12H3P	I12H3P	I12H3P	I12H3P
Min. pressure of the heating circuit	bar	0,5	0,5	0,5	0,5	0,5
Max pressure of the heating circuit	bar	3	3	3	3	3
Min. pressure of the healthcare circuit	bar	0,5	0,5	0,5	0,5	0,5
Max pressure of the DHW circuit	bar	6	6	6	6	6
Specific domestic water flow rate (Δt 30K)	l/min	11	12	13,3	14	14
Power supply		230V/1/50Hz				
Fuse on the power supply	A	3,15	3,15	3,15	3,15	3,15
Max power absorbed	W	87	87	87	102	102
Degree of protection		IP X4D	IP X4D	IP X4D	IP X4D	IP X4D
Methane consumption (max heating flow rate)*	m ³ /h	2,08	2,54	2,90	3,37	3,55
LPG consumption (max heating flow rate)*	m ³ /h	0,64	0,75	0,83	0,97	1,35
Maximum operating temperature in DHW	°C	60	60	60	60	60
Total capacity of expansion tank	l	7	9	9	9	9
Empty weight	Kg	29,2	29,9	31,4	33,0	33,0

* Value referred to 15 °C - 1013 mbar

Boiler operating data table BLU 20 - 24 - 28 - 32 - 34

Model	Heating and DHW heat flow kW	Thermal power with ΔT 80-60 °C kW (max / min)	Thermal power with ΔT 50-30 °C kW (max / min)	Average seasonal yield	Heating energy efficiency class	Profil DHW
BLU 20	20,0 / 24,0	19,0 / 2,5	21,0 / 2,5	92,0%	A / A+*	A (XL)
BLU 24	24,0 / 28,0	23,7 / 2,5	24,9 / 2,9	94,0 %	A / A+*	A (XL)
BLU 28	28,0 / 31,0	27,3 / 2,9	30,6 / 3,2	94,0 %	A / A+*	A (XL)
BLU 32	32,0 / 34,5	31,3 / 3,3	35,1 / 3,5	94,0 %	A / A+*	A (XL)
BLU 34	34,5 / 34,5	33,3 / 3,3	36,1 / 3,5	94,0 %	A / A+*	A (XL)

* Class A+ with class V remote control and external probe.

BLU - BLU EXTRA S

Wall-mounted gas condensing boilers

Boiler combustion data table BLU 20

DESCRIPTION	U.M.	Pmax	Pmin
Shell leaks when the burner is working		0,4%	8,2%
Leaks with burner off		0,3%	2,4%
Chimney leaks when the burner is working		3,7%	1,8%
Mass flow rate of fumes	g/s	9,9	1,3
Smoke temperature	°C	70,0	62,0
Thermal efficiency useful for power max (60/80 °C)			95,8%
Thermal efficiency useful for power max (30/50 °C)			103,4%
Thermal efficiency useful for power min. (60/80 °C)			90,0%
Thermal efficiency useful for power min. (30/50 °C)			102,1%
Useful thermal efficiency at 30% of the load			107,1%
Emission class NOX			6

Boiler combustion data table BLU 24

DESCRIPTION	U.M.	Pmax	Pmin
Shell leaks when the burner is working		0,4%	8,2%
Leaks with burner off		0,3%	2,4%
Chimney leaks when the burner is working		3,7%	1,8%
Mass flow rate of fumes	g/s	11,9	1,3
Smoke temperature	°C	70,0	62,0
Thermal efficiency useful for power max (60/80 °C)			98,8%
Thermal efficiency useful for power max (30/50 °C)			103,7%
Thermal efficiency useful for power min. (60/80 °C)			90,0%
Thermal efficiency useful for power min. (30/50 °C)			102,1%
Useful thermal efficiency at 30% of the load			109,8%
Emission class NOX			6

Boiler combustion data table BLU 28

DESCRIPTION	U.M.	Pmax	Pmin
Shell leaks when the burner is working		1,6%	5,0%
Leaks with burner off		0,15%	0,1%
Chimney leaks when the burner is working		2,3%	2,1%
Mass flow rate of fumes	g/s	13,0	1,6
Smoke temperature	°C	68,0	65,0
Thermal efficiency useful for power max (60/80 °C)			97,4%
Thermal efficiency useful for power max (30/50 °C)			109,2%
Thermal efficiency useful for power min. (60/80 °C)			92,9%
Thermal efficiency useful for power min. (30/50 °C)			102,8%
Useful thermal efficiency at 30% of the load			110,2%
Emission class NOX			6

Boiler combustion data table BLU 32

DESCRIPTION	U.M.	Pmax	Pmin
Shell leaks when the burner is working		1,3%	2,5%
Leaks with burner off		0,2%	1,8%
Chimney leaks when the burner is working		2,4%	1,8%
Mass flow rate of fumes	g/s	15,0	1,9
Smoke temperature	°C	74,5	63,0
Thermal efficiency useful for power max (60/80 °C)			97,1%
Thermal efficiency useful for power max (30/50 °C)			109,8%
Thermal efficiency useful for power min. (60/80 °C)			95,7%
Thermal efficiency useful for power min. (30/50 °C)			103,5%
Useful thermal efficiency at 30% of the load			110,7%
Emission class NOX			6

BLU - BLU EXTRA S

Wall-mounted gas condensing boilers

Boiler combustion data table BLU 34

DESCRIPTION	U.M.	Pmax	Pmin
Shell leaks when the burner is working		1,3%	2,5%
Leaks with burner off		0,2%	1,8%
Chimney leaks when the burner is working		2,4%	1,8%
Mass flow rate of fumes	g/s	15,0	1,9
Smoke temperature	°C	74,5	63,0
Thermal efficiency useful for power max (60/80 °C)			97,3%
Thermal efficiency useful for power max (30/50 °C)			104,5%
Thermal efficiency useful for power min. (60/80 °C)			95,7%
Thermal efficiency useful for power min. (30/50 °C)			103,5%
Useful thermal efficiency at 30% of the load			110,0%
Emission class NOX			6

Boiler technical data table BLU EXTRA S 32

DESCRIPTION	U.M.	BLU EXTRA S 32
Device category		I12H3P
Minimum pressure of the heating circuit	bar	0,5
Maximum pressure of the heating circuit	bar	3
Power supply		230V/1/50Hz
Fuse on the power supply	A	3,15
Max power absorbed	W	102
Degree of electrical protection		IP X4D
Methane gas consumption at max flow rate in heating*	m ³ /h	3,37
LPG consumption at max flow rate in heating*	m ³ /h	0,97
Total capacity of expansion tank	l	9
Empty weight	Kg	33,0

* Value referred to 15 °C - 1013 mbar

Boiler operating data table BLU EXTRA S 32

Model	Heating heat flow kW	Thermal power ΔT 80-60 °C kW (max / min)	Thermal power ΔT 50-30 °C kW (max / min)	Average seasonal yield	Heating energy efficiency class
BLU EXTRA S 32	32,0	31,1 / 3,3	35,1 / 3,5	94,0 %	A / A+*

* Class A+ with external probe.

Boiler combustion data table BLU EXTRA S 32

DESCRIPTION	U.M.	Pmax	Pmin
Shell leaks when the burner is working		1,3%	2,5%
Leaks with burner off		0,2%	1,8%
Chimney leaks when the burner is working		2,4%	1,8%
Mass flow rate of fumes	g/s	15,0	1,9
Smoke temperature	°C	74,5	63,0
Thermal efficiency useful for power max (60/80 °C)			97,1%
Thermal efficiency useful for power max (30/50 °C)			109,8%
Thermal efficiency useful for power min. (60/80 °C)			95,7%
Thermal efficiency useful for power min. (30/50 °C)			103,5%
Useful thermal efficiency at 30% of the load			110,7%
Emission class NOX			6