



Monoblock heat pump water heater

WHITE 80



WARNING

This unit is required reliable earthing before usage, otherwise might cause death or injury.



If you can't make sure that your house power supply is earthed well, please don't install the unit. Please have a qualified person perform the reliable earthing connection and the installation of the unit. Examples of a qualified person include: licensed plumbers, authorized electric company personnel, and authorized service personnel.

This installation manual needs to be used in conjunction with the safety manual.



CAUTION

- Children should be supervised to ensure that they do not play with the appliance.
- If the supply cord is damaged, it must be replaced by the manufacturer, its service agent or a similarly qualified persons in order to avoid a hazard.
- The wiring must be performed by professional technicians in accordance with national wiring regulations and the circuit diagram.
- The drainage pipe should be well insulated in order to prevent water inside pipe from freezing in cold weather.
- This appliance can be used by children aged from 8 years and above and persons with reduced physical, sensory or mental capabilities or lack of experience and knowledge if they have been given supervision or instruction concerning use of the appliance in a safe way and understand the hazards involved. Cleaning and user maintenance shall not be made by children without supervision.(FOR EN STANDARD)
- This appliance is not intended for use by persons (including children) with reduced physical, sensory or mental capabilities, or lack of experience and knowledge, unless they have been given supervision or instruction concerning use of the appliance by a person responsible for their safety.
- Children should be supervised to ensure that they do not play with the appliance.
- A discharge pipe connected to the pressure-relief device is to be installed in a continuously downward direction and in a frost-free environment.
- The water can drip from the discharge pipe of the pressure-relief device and that this pipe must be left open to the atmosphere.
- Regarding how the water heater can be drained, thanks to refer to the below paragraphs of the manual.
- Do not leave the packaging materials (staples, plastic bags, expanded polystyrene, etc.) within the reach of children - they can cause serious injury.
- The pressure-relief device is to be operated regularly to remove lime deposits and to verify that it is not blocked.
- Appliance shall be installed, operated and stored in a room with a floor area larger than 4m². The maximum refrigerant charge amount is 0.15kg
- **DANGER:**The operation of the thermal cut-out indicates a possibly dangerous situation. Do not reset the thermal cut-out until the water heater has been serviced by a qualified person.
- **DANGER:** Failure to operate the relief valve easing gear at least once every six months may result in the water heater exploding. Continuous leakage of water from the valve may indicate a problem with the water heater.

Your safety is the most important thing we concerned!

- It is mandatory to screw on to the appliance's water intake pipe a suitable device against overpressure; The pressure-relief device is to be operated regularly to remove lime deposits and to verify that it is not blocked. In countries which acknowledge EN 1487, the appliance's water intake pipe must be equipped with a safety device compliant with said standard; it must be calibrated to a maximum pressure of 0.75 MPa, including at least a cock, check valve, safety valve and hydraulic load cut-out.
- It is normal that water drips from the overpressure safety device or from the EN 1487 safety unit when the appliance is heating. For this reason one must install a drain, open to the air, with a continuously downwards sloping pipe, in an area not subject to subzero temperatures. A condensate drain should also be connected to the same pipe with a special coupling.
- Make sure you drain the appliance when it is out of service in an area subject to subzero temperatures. Drain as described in the appropriate chapter.
- Water heated to over 50°C can cause immediate serious burns if delivered directly to the taps. Children, disabled persons and the aged are particularly at risk. We recommend installing a thermostatic mixer valve on the water delivery line.
- Do not leave flammable materials in contact with or in the vicinity of the appliance.
- If the unit has an auxiliary electric heater, it must be installed at least 1 meter (40in) away from any combustible materials.
- How to fixed the appliance to its support please refer to detail information of installation.
- In order to avoid a hazard due to inadvertent resetting of the thermal cut-out, this appliance must not be supplied through an external switching device, such as a timer, or connected to a circuit that is regularly switched on and off by the utility.

PARTS NAMES

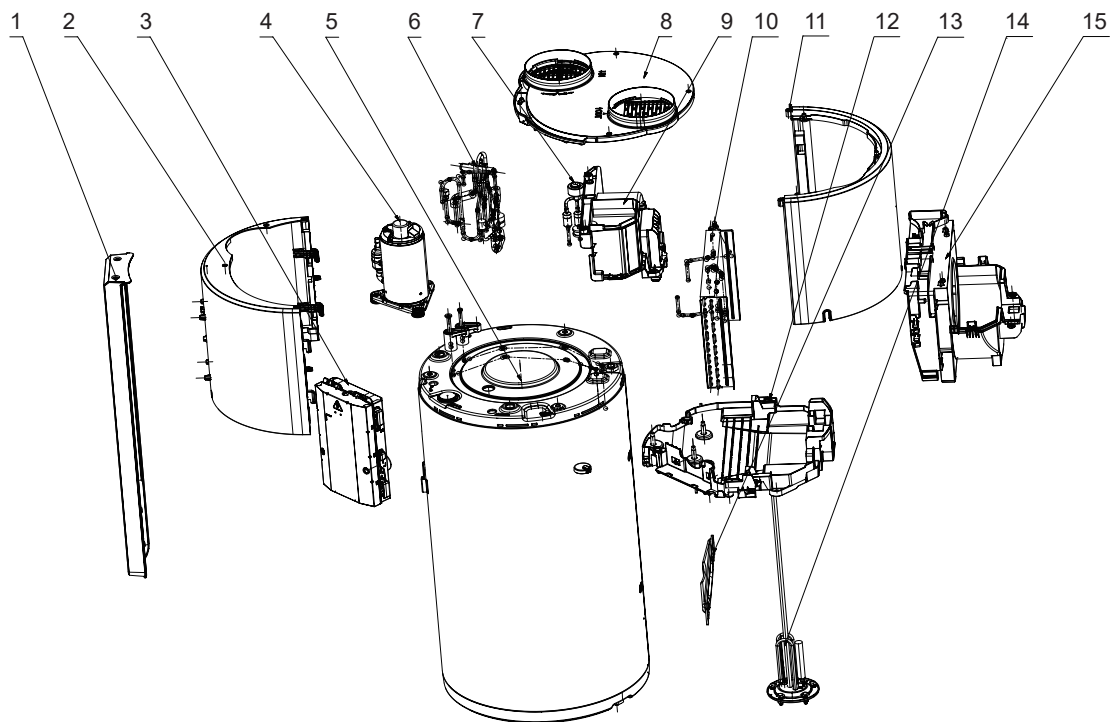

| | | | | |
|---------------------|---------------|------------------------------|----------------------|------------------|
| 1:Front plate | 4:Compressor | 7:Electronic expansion valve | 10:Evaporator | 13:Mount bracket |
| 2:Front cover plate | 5:Water tank | 8:Top plate | 11:Black Cover plate | 14:Heater |
| 3:Control box | 6:4-Way valve | 9:Upper cabinet | 12:Drain pan | 15:Lower cabinet |



NOTE

All the picture in this manual are for explanation purpose only. They may be slightly different from the heat pump water heater you purchased (depend on model). Please refer to the real sample instead of the picture of this manual.



CONTENTS

PAGE

| | |
|--------------------------------|----|
| SAFETY INFORMATION..... | 1 |
| BASIC OPERATION PRINCIPLE..... | 1 |
| BEFORE INSTALLATION..... | 3 |
| INSTALLATION..... | 4 |
| TRIAL-RUNNING..... | 10 |
| OPERATION | 13 |
| TROUBLE SHOOTING..... | 19 |
| MAINTENANCE..... | 21 |
| SPECIFICATIONS..... | 22 |

0. SAFETY INFORMATION

Please read thoroughly all of the instructions before installing or operating the unit. Following safety symbol is very important, always read and obey all safety symbol:

| | |
|--|--|
|  CAUTION | You may be injured if you don't obey instructions. |
|  WARNING | You may be killed or seriously injured if you don't obey instructions. |
|  DANGER | You may be killed or seriously injured immediately if you don't obey instructions. |

 **WARNING**

- The unit must be earthed effectively. A creepage breaker must be installed adjacent to the power supply.
- Do not remove, cover or deface any permanent instructions, labels, or the data label from either the outside of the unit or inside of unit panels.
- Ask qualified person to perform the installation of this unit in accordance with local national regulations and this manual.
- Improper installation may result in water leakage, electric shock or fire.
- Ask qualified person for relocating, repairing and maintaining the unit instead of doing by yourself.
- Electric connection work should obey the instructions of local power company, local electric utility and this manual.
- Never use the wire and fuse with wrong rated current, otherwise unit may break down and cause fire furthermore.
- Do not insert fingers, rods or other objects into the air inlet or outlet.
- When the fan is rotating at high speed, it will cause injury.

- When the fan is rotating at high speed, it will cause injury.
- Never use a flammable spray such as hair spray, lacquer paint near the unit. It may cause a fire. If the supply cord is damaged, it must be replaced by the manufacturer or its service agent or a similarly qualified person.
- The Minimum water pressure of the water transmission pipeline system is 0.15MPa.
- A pressure reducer (not supplied) is needed when pressure is more than 5 bar (0.5 MPa) and it will be placed on the main supply.

1. BASIC OPERATION PRINCIPLE

As we know with our experience, the natural flow of heat, which moves from a higher to a lower temperature source. the heat pump can transfer heat from a lower temperature source to a higher temperature source with high efficiency.

The advantage of a heat pump water heater is that it can supply more heat energy, normally 3 times than input electricity power by extracting the heat from ambient atmosphere in a free charge way to Sanitary Hot Water, compare to the traditional water heater, such as electric water heater or gas burner water heater, their efficiency is normally less than 1, which means it will dramatically cut off the bill of family daily SHW by the application of heat pump water heater, following data will show more details.

Power consumption comparison under the same condition to heat 1 ton water from 15°C to 55°C

$$\text{The equivalent heat load } Q = CM(T_1 - T_2) = 1(\text{kCal/kg} \cdot \text{°C}) \times 1000(\text{kg}) \times (55 - 15)(\text{°C}) = 40000 \text{ kCal} = 46.67 \text{ kW} \cdot \text{h}$$

Table. 0-1

| | HPWH | Gas Burner | E-heater |
|--------------------------|------------------|--------------|---------------|
| Energy Resource | Air, Electricity | Gas | Electricity |
| Transfer Factor | 860kCal/kW*h | 24000kCal/m³ | 860kCal/kW*h |
| Average Efficiency (W/W) | 3.9 | 0.8 | 0.95 |
| Energy Consumption | 11.93kW*h | 2.08m³ | 49.13 kW*h |
| Unit Cost | 0.09 USD/kW*h | 2.84 USD/m³ | 0.09 USD/kW*h |
| Running Cost USD | 1.1 | 5.9 | 4.42 |

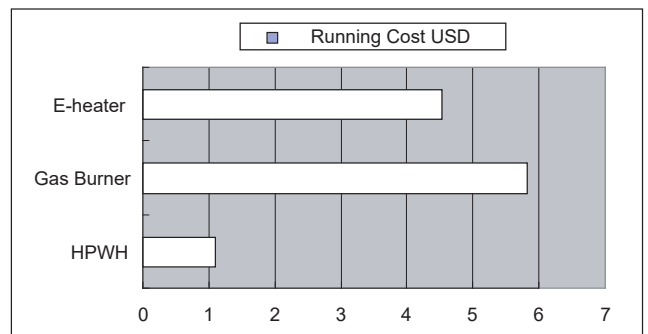

Fig.0-1



NOTE

Above calculation is based on the ideal condition, the final cost bill will be different caused by the actual running conditions, such as running period, ambient temperature, etc.

- The water inlet temperature of the equipment shall not be lower than 4°C, and the Maximum water temperature of the equipment can be set as 65°C (by changing the Settings, it can be raised to 70).
- Install the appliance in a frost-free room. The warranty does not cover destruction of the appliance through excess pressure caused by a blockage in the safety valve.
- Ensure that the wall on which it is mounted can support the weight of the appliance filled with water.
- If the appliance has to be installed in a room or location with an ambient temperature always above 35°C, this room must be ventilated.
- Place the appliance in an accessible place.
- To allow the possible exchange of the heating element, leave a clearance of 450 mm below the ends of the tubes of the water heater.
- A new safety unit must be installed at the intake to the water heater, in a frost-free environment, with dimensions of G1/2" and with pressure of 0.75 MPa, compliant with local regulations in force.
- Connect the safety unit to a drain pipe kept in the open air, in a frost-free environment, with a permanent downward gradient, to remove any expansion water from the heating process, or drainage water from the water-heater
- No device (shut-off valve, pressure reducer, etc.) should be placed between the safety group and the cold water supply line of the water heater.
- Do not connect hot water piping directly to the copper piping. It must be equipped with a dielectric connection (not supplied with the appliance).
- In the event of corrosion of the threads of the hot water sprinkler not equipped with this protection, could not be applied.
- SMART mode is not recommended when water consumption is low or irregular.

This symbol indicates that this product shall not be disposed with other household wastes at the end of its service life. Used device must be returned to official collection point for recycling of electrical electronic devices. To find these collection systems please contact to your local authorities or retailer where the product was purchased. Each household performs important role in recovering and recycling of old appliance.

Appropriate disposal of used appliance helps prevent potential negative consequences for the environment and human health.

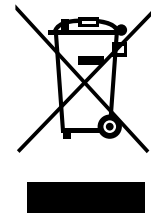

CAUTION

- The earthing pole of socket must be grounded well, make sure that power supply socket and plug are dry enough and connected tightly.
- How to check the power supply socket and plug are qualified?
Turn on power supply and keep the unit running for a half hour, then turn off power supply and plug out, check whether the socket and plug is hot or not.
- Before cleaning, be sure to stop the operation and turn the breaker off or pull out the power plug.
Otherwise, an electric shock and injury may be caused.
- Water temperature over 50°C can cause severe burns instantly or death from scalds. Children, disabled and elderly are at highest risk of being scalded. Feel water before bathing or showering.
- Water temperature limiting valves are recommended.
- Do not operate the unit with a wet hand.
An electric shock may be caused.
- The installation height of power supply should be over 1.8m, if there is any water splattered, separate the power supply from water.
- A one-way valve must be installed on the water inlet side, which is available from accessories, see manual "accessories" part.

Fig. 1-1

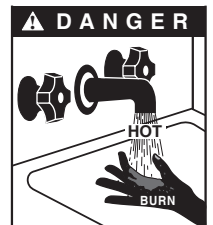

- After a long term use, check the unit base and fittings.
- If damaged, the unit may sink and result in injury.
- Arrange the drain pipe to ensure smooth draining.
- Improper drainage work may cause wetting of the building, furniture etc.
- Do not touch the inner parts of the controller.
- Do not remove the front panel. Some parts inside are dangerous to touch, otherwise a machine malfunction may be caused.
- Do not turn off the power supply.
- System will stop or restart heating automatically. A continuous power supply for water heating is necessary, except service and maintenance.
- If the unit has not been used for a long period of time(2 weeks or more), hydrogen gas will be produced in the water piping system. Hydrogen gas is extremely flammable. To reduce the risk of injury under these conditions, it is recommended that open the hot water tap for several minutes at the kitchen sink before using any electrical appliance connected to the hot water system.
- When hydrogen is present, there will probably be an unusual sound such as air escaping through the pipe as the water begins to flow.
- There should be no smoking or open flame near the tap at the time it is open. Confirm the safety of the installation area (walls, floors, etc.) without hidden dangers such as water, electricity, and gas. Before wiring/pipes.
- Before installation , check whether the user's power supply meets the electrical installation requirements of unit (including reliable grounding , leakage , and wire diameter electrical load, etc.). If the electrical installation requirements of the product are not met, the installation of the product is prohibited until the product is rectified.
- When installing multiple units in a centralized manner, please confirm the load balance of the three-phase power supply, and multiple units are prevented from being assembled into the same phase of the three-phase power supply.
- Product installation should be fixed firmly, Take reinforcement measures, when necessary.

2. BEFORE INSTALLATION

2.1 Unpacking

2.1.1 Accessories

Table. 2-1



| Accessory Name | Qty. | Sharp | Purpose |
|-------------------------------|------|---|---|
| Owner's & Installation Manual | 1 |  | Installation and use instruction This manual |
| Safety Valve (0.75MPa) | 1 |  | Prevent tank overpressure, prevent flowing backwards |
| Expansion screw | 4 |  | Fixed unit |

Fig.2-1

2.1.2 How to transport

- 1) In order to avoid scratch or deformation of the unit surface, apply guard boards to the contacting surface. No contact of fingers and other things with the vanes. Don't incline the unit more than 75° in moving, and keep it vertical when installing.

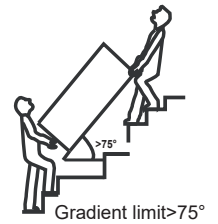

- 2) This unit is heavy, it need to be carried by two or more persons, otherwise might cause injury and damage.

2.2 Location requirements

- 1) Enough space for installation and maintenance shall be preserved.
- 2) The air inlet and outlet should be free from obstacles and strong wind.
- 3) The wall surface should be flat, surface should be inclined no more than 2° and able to bear the weight of the unit and suitable for installing the unit without increasing noise or vibration.
- 4) The operation noise and air flow expelled shall not affect neighbors.
- 5) No flammable gas is leaked nearby.
- 6) It is convenient for piping and wiring.
- 7) If it is installed in indoor space, it might cause indoor temp decreased and noise. Please take preventive measures for this.
- 8) If the unit has to be installed on a metal part of building, make sure the well electric insulation which should meet the relevant local electric standard.



CAUTION

- The ambient air temperature must also be considered when installing this unit, in heat pump mode the ambient air inlet temperature must be above -7°C and below 43°C. If the ambient air temperature falls outside these upper and lower limits, the electrical elements will be activated to meet the hot water demand and the heat pump does not operate.
- The unit should be located in an area not subject to freezing temperatures. The unit located in unconditioned spaces (i.e., garages, basements, etc.) may require the water piping, condensate piping, and drain piping to be insulated to shelter against freezing.



CAUTION

Installing the unit in any of the following places may lead to malfunction (If it is inevitable, consult the supplier).

- The site contains mineral oils such as lubricant of cutting machines.
- Seaside where the air contains much salt.
- Hot spring area where corrosive gases exist, e.g., sulfide gas.
- Factories where the power voltage fluctuates seriously.
- Inside a car or cabin.
- The place with direct sunlight and other heat supplies. If there's no way to avoid these, please install a covering.
- Place like kitchen where oil permeates.
- Place where strong electromagnetic waves exist.
- Place where flammable gases or materials exist.
- Place where acid or alkali gases evaporate.
- Other special environments.



WARNING

- The unit must be securely fixed, otherwise, noise and shaking may be resulted.
- Make sure that there's no obstacle around the unit.
- In the place where there is strong wind like seashore, fix the unit in the location protected from the wind.

3. INSTALLATION

3.1 Maintenance space requirements (unit: mm)

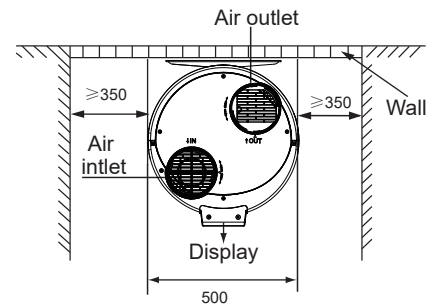

Fig.3-1

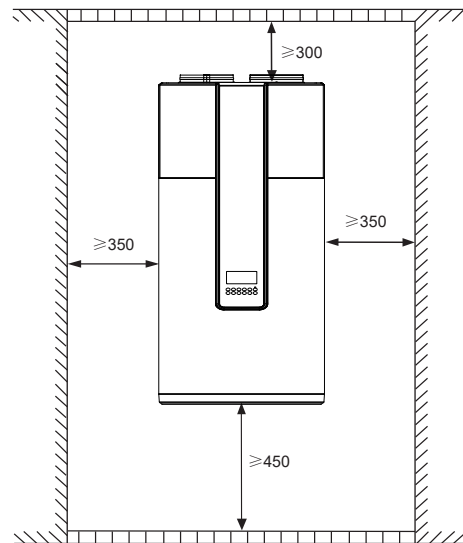
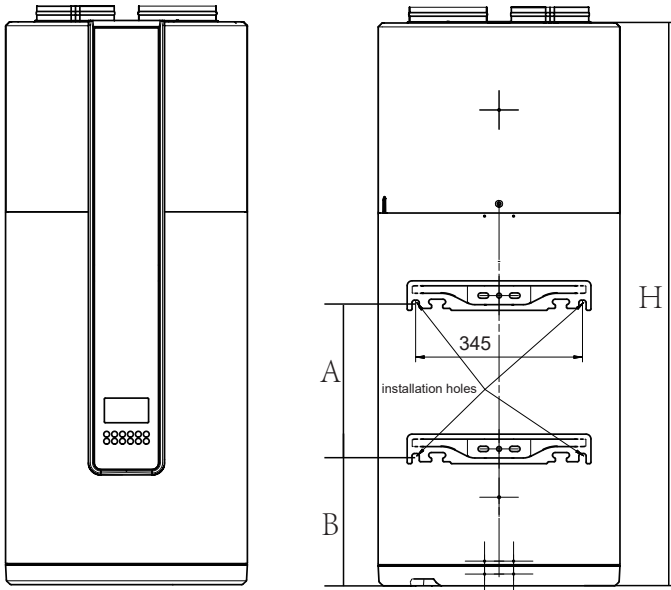

Fig.3-2

3.2 Mounting dimension



| Model | A | B | H |
|----------|-----|-----|------|
| WHITE 80 | 317 | 270 | 1164 |

Table. 3-1

- Place the water heater in a room protected from frost.
- Place it as close as possible to important points of use.
- Make sure that the support element is sufficient to receive the weight of the water heater full of water.

It is mandatory to install a retention basin below the water heater if installed above a living area. A drain connected to the sewer is required.

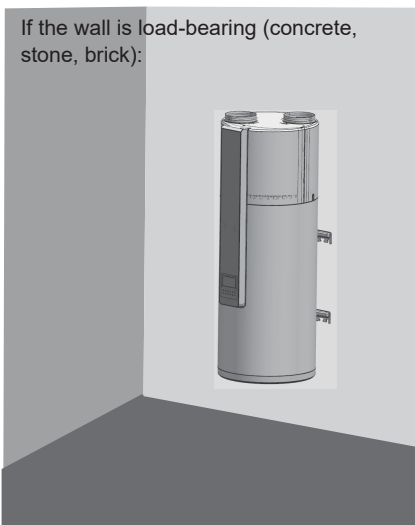

Fig.3-3

Mark the wall with reference to the requirements of the installation size (size drawing). Proceed to the bolting of bolts Ø 10mm. The wall must hold a minimum load of 300 kg.

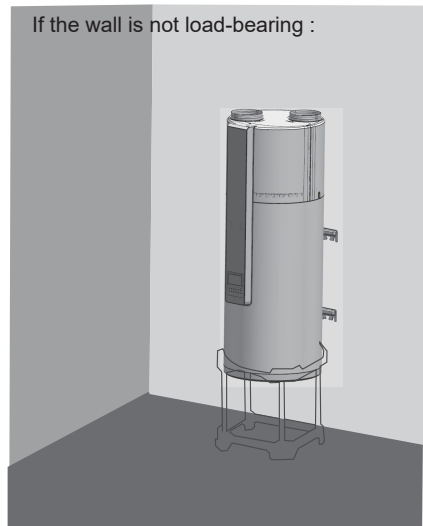

Fig.3-4

It is mandatory to install the water heater on a support . Place the water heater on the bracket to mark the fixing points. Make the holes and then reinstall the water heater in its place. The anti-tilting fixing by the upper bracket is obligatory (fixing Ø 10mm minimum adapted to the wall).

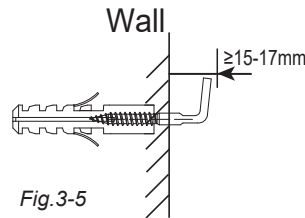

Fig.3-5

The hole size for hanging the wall should refer to the corresponding hole size in Figure 3-1 (two racks for each water tank, a total of four expansion bolts need to be fixed).

After the expansion bolt is tightened, the distance between the inner side of the bolt and the wall surface should be controlled within 15mm-17mm, as shown in the figure.

- 1) Installation of the Safety Valve: The spec of the One Way Valve thread in accessories is G1/2". It is used to prevent water from flowing backwards and prevent tank overpressure
- 2) After water system piping work, turn on the cold water inlet valve and hot water outlet valve and start effusing the tank. When water flow smoothly out from water outlet pipe(tap water outlet), the tank is full, turn off all valves and check pipeline to make sure there is no any leakage.
- 3) If the inlet water pressure is less than 0.15MPa, a pump should be installed at the water inlet. For guarantee the safety usage of tank at the condition of water supply pressure higher than 0.5MPa, a reducing valve should be installed at the water inlet pipe.
- 4) Condensate may be leaked from unit if drainage pipe is blocked or unit operates in high humidity environment, a drainage pan is recommended as shown as following figure:

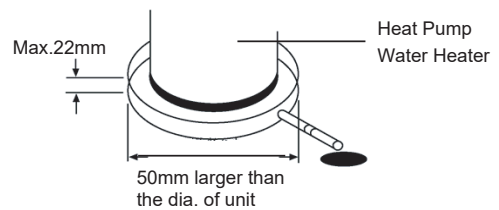

Fig.3-6

The water heater must be located in a space >15m³, and must have unrestricted air flow. As an example, a room that has an 2.5 tall ceiling and is 3 meter long by 2 meter wide would contain 15m³ .

Water inlet or outlet pipes: The spec of the water inlet or outlet thread is G1/2" (external thread). Pipes must be heat-insulated well.



CAUTION

- Mounting dimension as the above figure.
- The drainage pipe should be well insulated in order to prevent water inside pipe from freezing in cold weather.

Unit outline dimension (unit: mm)

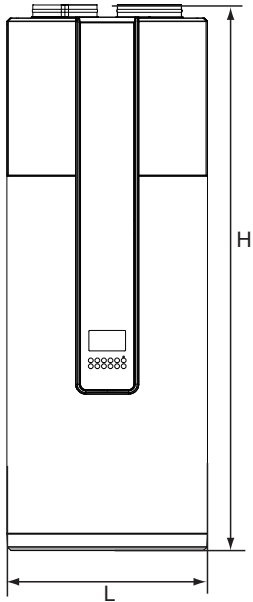

| Model | Dimension |
|----------|--------------------|
| WHITE 80 | 500 (L) × 1196 (H) |

Fig.3-7

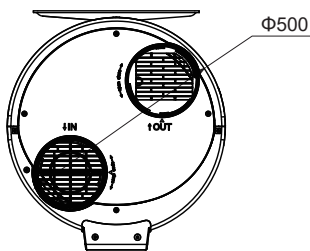

Fig.3-8

NOTE:
Use tools to disassemble the filter for cleaning.

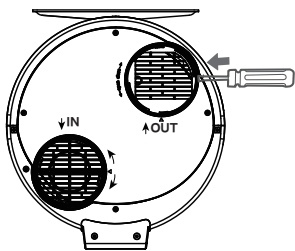

Fig.3-9

3.3 Air duct connection

- 1) Air inlet and outlet with duct. ($A+B \leq 5m$)

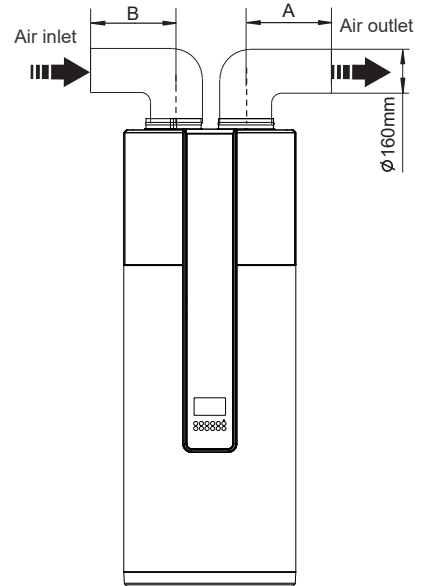

Fig.3-10

- 2) Air inlet without duct, air outlet connects to duct. ($A \leq 5m$)

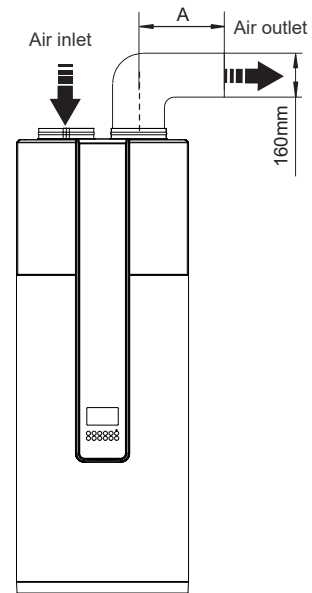

Fig.3-11

It is recommended to install unit by this way in the winter where there is other heat source in the room.

3) Air inlet connects to duct, air outlet without duct.(A≤5m)

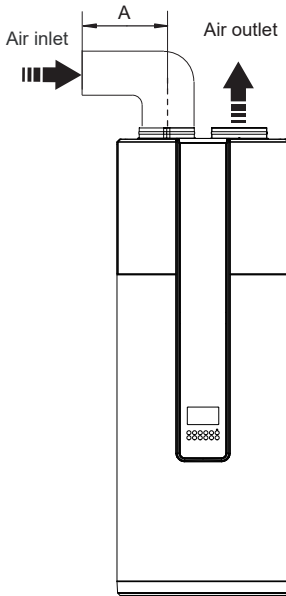

Fig.3-12

It is recommended to install unit by this way in summer that could charge fresh air into room.

4) Duct Description

Table. 3-2

| Duct(PVC) | Round duct | Rectangle duct |
|------------------------------------|------------|----------------|
| Dimension(mm) | Φ 160 | 160X160 |
| Straight-line pressure drop (Pa/m) | ≤2 | ≤2 |
| Straight-line length (m) | ≤5 | ≤5 |
| Bent pressure drop(Pa) | ≤2 | ≤2 |
| Bent's qty. | ≤3 | ≤3 |



NOTE

- The resistance of duct will decrease air-flow-rate, which will lead to capacity of unit decreased.
- For the case of unit with duct, the duct total length should be no more than 5m , and the quantity of bending should be no more than 3.
- For unit air outlet with duct, when unit operating, condensate will be generated around outside of duct. Please pay attention to the drainage work, we suggest to wrap the thermal insulated layer around outside of the duct.
- Must be install the unit in the indoor space, it is not allow to install the unit at the rainy space.

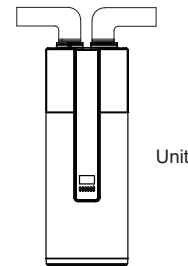

Fig.3-13



WARNING

- In case of rain entering to internal components of the unit, the component might be damaged or causing physical danger. (Fig.3-13)
- In terms of the unit connect with duct reaching to outdoor, a reliable water-resistant measure must be conduct on the duct, to prevent water from dropping into internal of the unit. (Fig.3-13)

- 5) Filter installing at the unit inlet. In terms of the unit with duct, filter in there must be put on the position of duct inlet. (Fig.3-14/3-15)

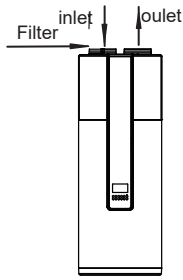
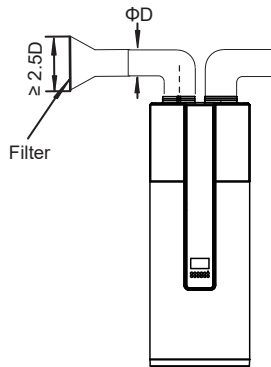

Fig.3-14



Owner should install the filter by self; and the mesh size is about 1.2mm.

Fig.3-15

- 6) To smoothly drain condensate from unit, please install the unit at a horizontal floor. Otherwise, please ensuring the drain vent is at the lowest place. Recommending the inclination angle of unit to the ground should be no more than 2°.

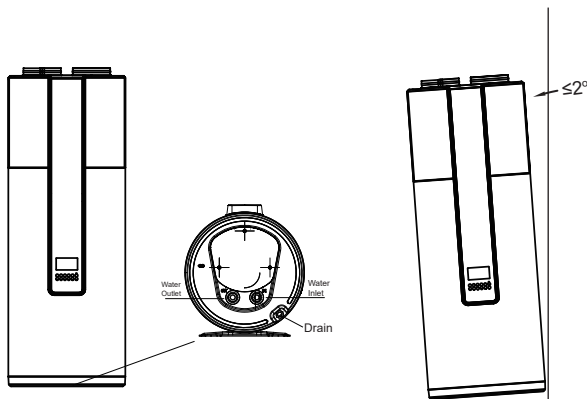

Fig.3-16

3.4 Electric Connection



CAUTION

- The power supply should be an independent circuit with rated voltage.
- Power supply circuit should be earthed effectively.
- The wiring must be performed by professional technicians in accordance with national wiring regulations and this circuit diagram.

- An all-pole disconnection device which has at least 3mm separation distance in all pole and a residual current device (RCD) with the rating of above 10mA (30 mA is recommended) shall be incorporated in the fixed wiring according to the national rule.
- Set the electric leakage protector according to the relevant electric technical standards of the state.
- The power cord and the signal cord shall be laid out neatly and properly without mutual interference or contacting the connection pipe or valve.
- After wire connection, check it again and make sure the correctness before power on.
- Products for indoor use only.

3.4.1 Specifications of Power Supply

Table. 3-2

| | |
|---|---------------|
| Model Name | WHITE 80 |
| Power Supply | 220-240V~50Hz |
| Min. Diameter of Power Supply Cord (mm ²) | ≥1.5 |
| Earth Cord (mm ²) | ≥1.5 |

- Please choose the power cord according to above table, and it should comply with local electric standard.
- The power cord model, recommended power cord mode is H05VV-F.
- When wiring the power supply, please add additional insulation sheath at the place without rubber insulation layer.



WARNING

The unit must be installed with an Creepage Breaker near the power supply and must be effectively earthed.

3.5 Cold water connection

Before connection check that the piping is clean without any particles from installation. The installation has to include a new safety valve set to 7 bar (0,75 MPa), compliant to EN 1487 and connected directly on the cold water inlet.

! No hydraulic device (stop valve, pressure reduction, flexible...) is allowed between the safety valve and the cold water inlet of the water heater.

As water can flow from the safety valve the drain should be kept in open air. In any type of installation there should be a cold water stop valve, before the safety valve.

The overflow of the safety valve has to be connected to the used water evacuation through a siphon. Installation has to be in a frost-free environment. The safety valve has to be operated regularly to check the working condition (1 - 2 times per month).

The installation should be equipped with a pressure reduction if the main water supply pressure is higher than 5 bar (0,5 MPa). The pressure reducing device has to be installed at the beginning of the distribution network (before the safety valve). We recommend a supply pressure of 3 - 4 bar (0,3 to 0,4 MPa). The appliance cannot be connected by a hose-set.

! CAUTION

For regions with a lot of scale ($T_h > 20^\circ\text{f}$), we recommend to treat the water. The hardness after softener has to be higher than 15 $^\circ\text{f}$. The use of a softener does not influence the warranty if the softener is approved for the country of installation and set to the rules of art, with regular checking and maintenance. Local criteria of drinking water quality have to be respected.

3.6 Hot water connection

! Do not connect copper tubes directly on the tank connection. You have to fit the supplied insulation union (not included in the supply). In case that the tank connection is corroded without this protection the warranty will not apply.

! If the installation is made with synthetic pipes (e.g. : PER, multi-layer...), install mandatory a thermostatic control valve at the connection pipes of the water heater. The setting should be done in relation with the specification of the installed piping.

3.7 Condensate evacuation

! The temperature drop of the air passing through the exchanger forms condensation from humidity in the air. The condensed water is evacuated on the rear of the tank using the supplied plastic tube.

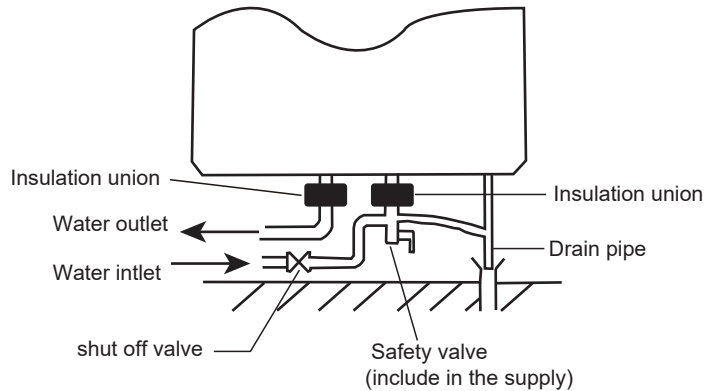

Depending on the degree of humidity in the air you can get up to 0,25l/h of condensation. The evacuation of condensate should not be made directly to sewer water because of possible corrosive gasses damaging the exchanger fins and water heater parts.

! WARNING



Do not block off the safety valve drainage pipe. It will cause explosion and injury, if do not comply with the above instruction.

3.7.1 Electric leakage protector

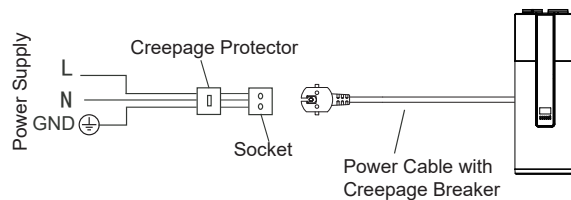

3.8 Installation checklist

3.8.1 Location

- The wall must hold a minimum load of 300 kg.
- Located indoors (such as a basement or garage) and in a vertical position. Sheltered from freezing temperatures.
- Provisions made to shelter the area from water damage. Metal drain pan installed and piped to an adequate drain.
- Sufficient room to service the water heater.
- Sufficient air for the heat pump to function, the water heater must be located in a space >15m³, and must have unrestricted air flow.
- All piping properly installed and free of leaks.
- Unit completely filled with water.
- Water temperature limit valve or mixer tap(recommended) installed per manufacturer's instructions.
- The installation has to include a new safety valve set to 0,75 Mpa, compliant to EN 1487 and connected directly on the cold water inlet. No hydraulic device (stop valve, pressure reduction, flexible...) is allowed between the safety valve and the cold water inlet of the water heater.
- As water can flow from the safety valve the drain should be kept in open air. In any type of installation there should be a cold water stop valve, before the safety valve. The overflow of the safety valve has to be connected to the used water evacuation through a siphon. Installation has to be in a frost-free environment. The safety valve has to be operated regularly to check the working condition (1 - 2 times per month). The installation should be equipped with a pressure reduction if the main water supply pressure is higher than 5 bar (0,5 MPa). The pressure reducing device has to be installed at the beginning of the distribution network (before the safety valve). We recommend a supply pressure of 0,3 to 0,4 MPa.

3.8.2 Water System Piping

- All piping properly installed and free of leaks.
- Unit completely filled with water.
- Water temperature limit valve or mixer tap(recommended) installed per manufacturer's instructions.

3.8.3 Condensate Drain Line Installation

- Must be located with access to an adequate drain or condensate pump.
- Condensate drain lines installed and piped to an adequate drain or condensate pump.

3.8.4 Electrical Connections

- The water heater requires 220-240 VAC for proper operation.
- Wiring size and connections comply with all local applicable codes and the requirements of this manual.
- Water heater and electrical supply are properly grounded.
- Proper overload fuse or circuit breaker protection installed.

3.8.5 Post Installation Review

- Understand how to use the User Interface Module to set the various modes and functions.
- Understand the importance of routine inspection/maintenance of the condensate drain pan and lines. This is to help prevent any possible drain line blockage resulting in the condensate drain pan overflowing.
- **IMPORTANT:** Water coming from the plastic shroud is an indicator that both condensation drain lines may be blocked. Immediate action is required.
- To maintain optimal operation check, remove and clean the air filter.

4. TRIAL-RUNNING

4.1 Water affusion before operation

Before using this unit, please follow the steps below.

Water Affusion: If the unit is used for the first time or used again after emptying the tank, please make sure that the tank is full of water before turning on the power.

Method: see Fig.4-1

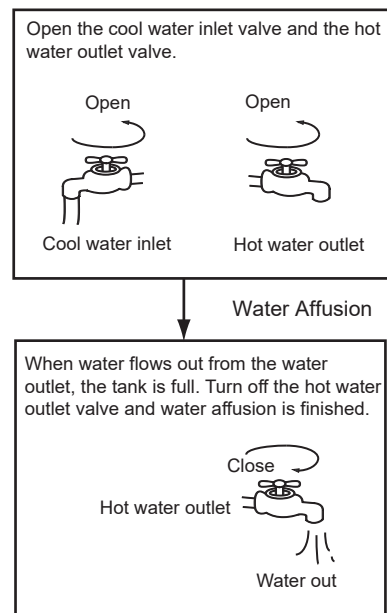
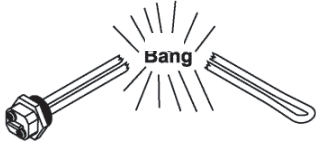

Fig.4-1



CAUTION

- Operation without water in water tank may result in the damage of auxiliary e-heater. Due to such damage, manufacturer will not be liable for any damages caused by this issue.



- After powered on, the display lights up. Users can operate the unit through the buttons under the display.
- Emptying: If the unit needs cleaning, moving etc, the tank should be emptied. Method: See Fig.4-2:

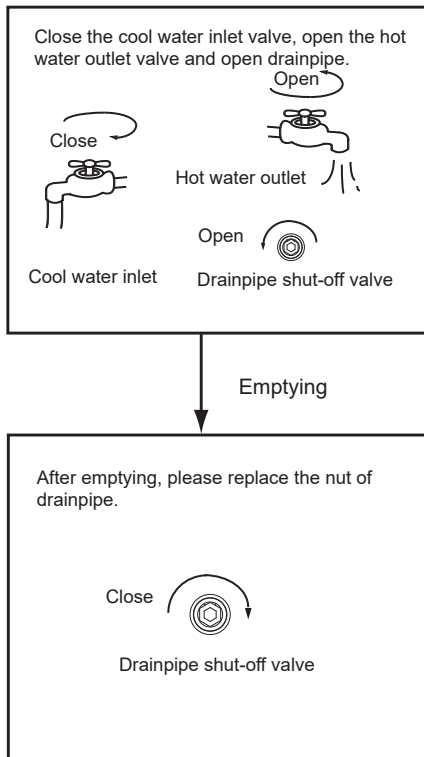

Fig.4-2

4.2 Trial- running

4.2.1 Checking list before commissioning.

- 1) Checking list before trial-running.
- 2) Correct installation of the system.
- 3) Correct connection of water/air piping and wiring.:
- 4) Condensate draining smoothly well insulation work for all hydraulic part.
- 5) Correct power supply.
- 6) No air in the water pipeline and all valves opened.
- 7) Effective electric leakage protector installation.
- 8) Sufficient inlet water pressure (between 0.15MPa and 0.5MPa).

4.2.2 About Running

- 1) System Structure Figure
Unit has two kinds of heat sources: heat pump(compressor) and electric heater.
Unit will automatically select heat sources to heat water to the target temperature.

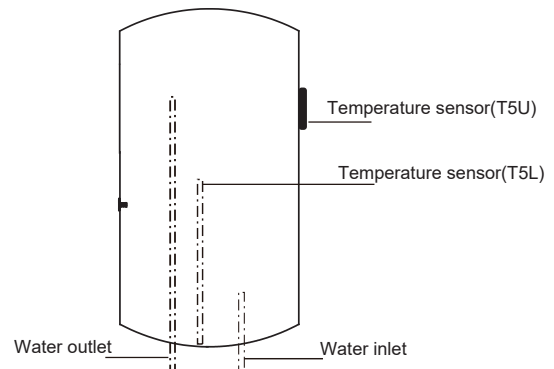

Fig.4-3

- 2) Water Temperature Display
The temperature shown on the display depends on the maximum of the upper sensor and the lower sensor.
- 3) Modes will be automatically selected by unit. manually mode selection is unavailable.
 - Running Temperature Range
Setting water temperature target range: 38~65°C.

Table. 4-1

| | | |
|--|-----------|-------|
| Min. temperature of room of installation | 0°C | |
| Max. temperature of room of installation | 43°C | |
| Minimum air inlet temperature(a) | Heat pump | -7°C |
| | E-heater | -20°C |
| Maximum air inlet temperature(a) | Heat pump | 43°C |
| | E-heater | 45°C |

(a):Air inlet temperature range through air duct from outside (for models with air inlet duct).

Table. 4-2

| Ambient air inlet Temp.(T4) | T4<-7 | -7≤T4<-2 | -2≤T4<2 | 2≤T4<35 | 35≤T4<43 | 43≤T4 |
|-----------------------------|---|----------|---------|---------|--------------------------|-------|
| Max.Temp.(Heat pump) | -- | 45 | 55 | 65 | 60(80L/100L) 58(150L) | -- |
| Max.Temp.(E-heater) | 70°C(The maximum outlet temperature is set to 65°C by default.) | | | | | |

4) Heat Source Shift

- The default heating source is heat pump. If ambient is range out of heat pump, heat pump will stop running, the unit will shift automatically to activate E-heater, then if the ambient temperature goes into the running range of heat pump again, it will stop E-heater and shift automatically to heat pump again.
- If the target setting water temperature is higher than Max. temp(Heat pump), the unit will activate heat pump firstly to the Max. temperature, then stop heat pump, activate E-heater to continually heat water to the target temperature.
- If manually activate the E-heater running when heat pump running, E-heater and heat pump will work together until the water temperature gets to target temperature. So if want to heat quickly, please manually activate E-heater.



NOTE

E-heater will be activated once for the current heating progress, if want to apply E-heater again, please push again.

- If system occurs some malfunctions, error code "EHHP" and will be shown on the display, then heat pump will stop running, and the unit will activate automatically E-heater as the backup heat source, but the code "EHHP" and will be shown until power off.
- Defrosting During Water-heating
In heat pump running period, if the evaporator frosted in lower ambient temperature, the system will defrost automatically to keep effective performance(about 3~10min). At defrosting time(when the ambient temperature is below 5°C), the fan motor will stop, but compressor will still run.
- Heat-up Time
There are different heat-up times in different ambient temperature. Normally lower ambient temperature result longer heat-up time because of lower effective performance. In the ECO mode, the heating time (water temp from 15-55 °C) ,please refer to Table.4-3.Time difference may occur due to different installation scenarios. This is normal.

Table. 4-3

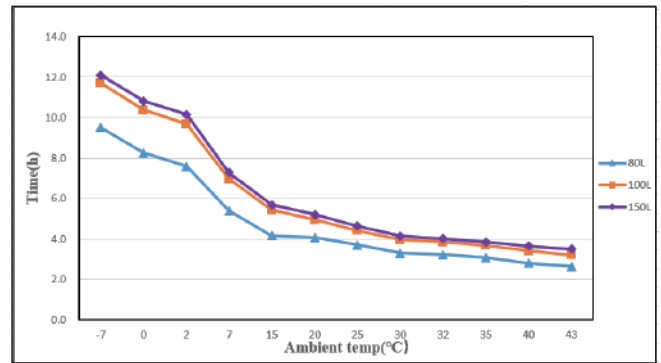

- When ambient temp below 2°C, heat pump and E-heater will take different portions of heating capacity,
- About TCO
The power of compressor and E-heater will be automatically shut-off or turn on by TCO .
If the water temperature is higher than 85°C, the TCO will automatically shut off the power of compressor and E-heater. After that it needs to be reset manually.
- Restart After a Long Term Stop
When the unit is restarted after a long term stop(trail running included), it is normal that outlet water is unclean. Keep the tap on and the water will be clean soon.



NOTE

While the ambient air inlet temperature below than -7°C, heat pump efficiency will decrease dramatically, the unit will automatically shift to E-heater running.

4.2.3 Basic function

- Weekly disinfect function
Under disinfection unit immediately start to heat water up to 65°C to kill the potential legionella bacteria inside water of tank, icon will light on the display screen during disinfection. Unit will quit disinfection if water temperature is higher than 65°C and extinguish icon.
- Vacation function
Press the button to select VACATION , unit will automatically heat water to 15°C for the purpose of energy saving during vacation days.
- How is the unit running
If unit is OFF->press ->unit will be waken->press to set target water temperature(38-65°C)->press ->unit will automatically select heat source and start to heat water to target temperature.
- Remote shutdown function:
Users can connect a switch. If the switch is closed, the unit will be stopped forcibly. If switch breaks, the unit can run normally according settings.

4.2.4 Query function

Press and hold the button for 1 second then system running parameters will be shown one by one with following sequence by each pushing of or button.

Table. 4-3

| No. | Hour low bit | Min. high bit | Min. Low bit | unit | Explanation |
|-----|--------------|---------------|--------------|--------------------|--|
| 1 | T | S | U | Temp. | T5U |
| 2 | T | S | L | Temp. | T5L |
| 3 | T | S | I | Temp. | ---- |
| 4 | | T | S | Temp. | Heat pump stop temp |
| 5 | | T | 3 | Temp. | T3 |
| 6 | | T | 4 | Temp. | T4 |
| 7 | | T | P | Temp. | TP |
| 8 | | T | H | Temp. | Th |
| 9 | | o | n | | ---- |
| 10 | T | F | r | | ---- |
| 11 | | T | T | Temp. | Disinfect temp. |
| 12 | | L | o | Current | Compressor and electric heating current |
| 13 | | F | o | Fan | Ac Fan Dc Fan 0: OFF Real speed/10 1: LOW 2: MID 3: HIGH |
| 14 | | E | o | Machine parameters | 0~255 |
| 15 | E | E | r | | Electronic expansion valve opening |
| 16 | E | E | L | | Compression mechanism hot water demand |
| 17 | P | U | P | | ---- |
| 18 | | P | S | | ---- |
| 19 | | F | T | | 0: Ac Fan 1: Dc Fan |
| 20 | | H | T | | 1(Eheater control type) |
| 21 | | H | P | | 0(Compressor control type) |
| 22 | F | S | I | | ---- |
| 23 | S | I | o | | Tank capacity |
| 24 | P | 4 | P | | Four-way valve status |
| 25 | | U | U | | 0 |
| 26 | | U | I | Version | Host software version |
| 27 | | U | 2 | Version | LCD panel software version |
| 28 | | U | 3 | Version | 000 |

| | | | | | |
|----|---|---|---|--|---|
| 29 | | U | 4 | | 0: One electric heater 1: Two electric heaters |
| 30 | | U | T | | 3 |
| 31 | I | E | r | | Last error code |
| 32 | 2 | E | r | | Previous 1 st error or protection code |
| 33 | 3 | E | r | | Previous 2 nd error or protection code |
| 34 | H | H | H | | Maintenance time |
| 35 | T | L | F | | Target Temp |
| 36 | E | n | d | | End sign |

5. OPERATION

5.1 Control Panel Explanation

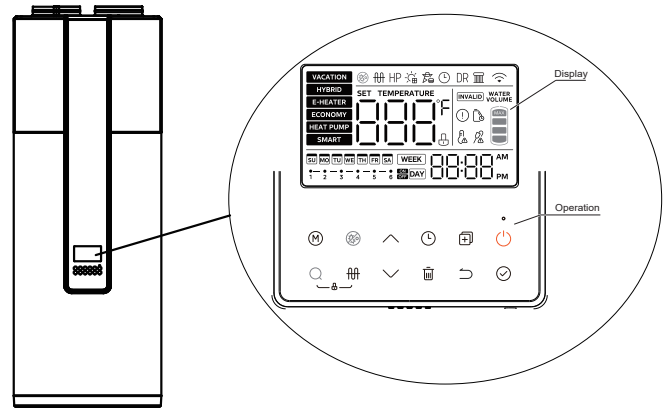

Fig.5-1

5.2 Display Explanation

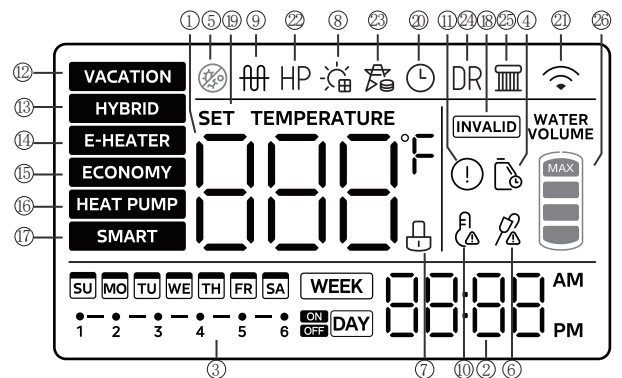

Fig.5-2

Table. 5-1

| No | Icon | Description |
|----|------|---|
| ① | | 8888 will be lightened if screen is unlocked. It shows water temperature on normal; It shows remaining vacation days on vacation; It shows setting temperature on setting; It shows unit setting/running parameters, error/protection code on querying. |
| ② | | Time and clock setting 20:00 shows the clock. Whenever there is any setting for clock, SET TIME will be lightened. |
| ③ | | There are daily or weekly TIMER icon. If anyone of them has been set, this icon will lighten the corresponding one when screen is unlocked; If there is none of timers has been set, it will keep extinguished. If timer is being set, this icon will flash the corresponding one with 2Hz frequency as well lighten the timer which has been set. |
| ④ | | It flashes to remind the user to maintain the water tank. If you do not need maintenance reminders, you can enter engineering mode channel 2 to disable this function, or engineering mode channel 4 to reset the maintenance reminder time, the default maintenance reminder time is 365 days. |
| ⑤ | | It will be lightened when the machine is disinfecting. |
| ⑥ | | Electronic magnesium rod reminder: It will be lightened when the electronic magnesium rod reaches the end of its service life. (some units) |
| ⑦ | | Lock: If button is locked, the icon will be lightened, otherwise it will be extinguished. |
| ⑧ | | EVU: When the photovoltaic effective signal is detected, this icon lights up, this time the target temperature of the machine is adjusted to the highest set temperature, and the machine makes hot water quickly. (some units) |
| ⑨ | | E-heat: It will be lightened when E-heat is running, otherwise it will be extinguished. NOTE: When the operating conditions are not met to turn on this function, the corresponding icon on the wire controller lights up briefly and then goes out. |

| | | |
|---|----------|---|
| ⑩ | | High temp. Alarm If water temp is higher than 50°C, it will be lightened, otherwise it will be extinguished. |
| ⑪ | | Error: It will be lightened when unit is under protection/error. |
| ⑫ | | VACATION MODE: For the outgoing vacation mode, the water tank is set at 15°C. Maintains low tank water temperature, preheats hot water and anti-freeze lines, while reducing on/off operation of the tank. |
| ⑬ | | HYBRID MODE: Operating in heat pump mode, the electric heater and heat pump will heat up together when in extremely low ambient temperatures or when the heat pump has been running for a long time without reaching the set Temp. |
| ⑭ | | E-HEATER MODE: Operate in accordance with the heat pump mode, the heat pump outdoor unit and the electric heater running at the same time. |
| ⑮ | | ECONOMY MODE: In accordance with the heat pump mode of operation, the heat pump external unit heats up to the maximum water temperature before turning on the electric auxiliary heater for heating, the heat pump and the electric auxiliary heater will not be turned on at the same time. It is recommended to use this mode of operation when making hot water alone, which is more energy-saving. |
| ⑯ | | SMART MODE: Records the hot water usage habits of users over the past 7 days and turns on the heating in advance according to the user's peak water usage hours. All other unconventional hot water hours are in standby mode, without heating operation (it is recommended that users set this mode after 7 days of regular and normal operation of the water heater to avoid affecting the normal use of the water heater by failing to record the complete user habits.) |
| ⑰ | INVALID | When any key is invalid, this icon will flash 3 sec. |
| ⑱ | SET TEMP | The icon lights up when the water temperature is being set. |
| ⑲ | | The icon lights up when the clock is being set. |
| ⑳ | | Wireless: will be lightened when Wireless is connected; will be extinguished when Wireless is not connected; will flash with 2Hz frequency when setting Wireless. |
| ㉑ | HP | HEAT PUMP ICON: When the heat pump is operating and producing hot water, the icon lights up. |
| ㉒ | | Smart Grid ICON: When the SG signal is invalid, this icon does not light up and the machine does not switch on normally. (some units) |

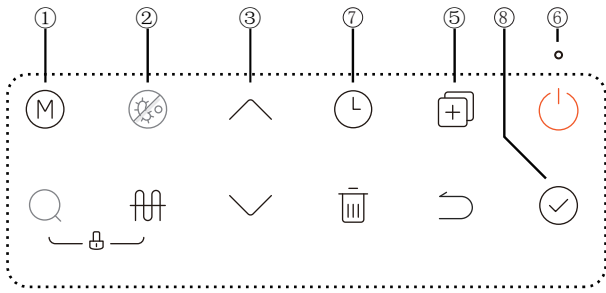

Fig. 5-3

Any pressing of button is effective only under button and display unlocked state.

Table. 5-2

| No. | Icon | Description |
|-----|------|--|
| ① | | <p>Use this key to switch mode</p> <ul style="list-style-type: none"> Default HYBRID mode Switch to E-heater mode Switch to ECONOMY mode Switch to smart mode Switch to VACATION mode Adjust vacation days (1-360 days) Switch to HYBRID mode |
| ② | | <p>Click the button to turn on the forced sterilization function.</p> <ul style="list-style-type: none"> Icon will light up. then the unit will heat up water to 65°C at least for disinfection. When the machine is disinfected, press this button to cancel it. then the will be extinguished. This key is used to cancel all settings and exit the setting state. When Wireless connection is normal, long press the Cancel button for more than 8s to exit Wireless connection. <p>NOTE: When the operating conditions are not met to turn on this function, the corresponding icon on the wire controller lights up briefly and then goes out.</p> |

| No | Icon | Description |
|----|------|--|
| ③ | | <p>INCREASE AND DECREASE</p> <p>If screen is unlocked, corresponding value will increase by pressing the button.</p> <ul style="list-style-type: none"> When setting temperature, press more than 1s, temperature value will be increased continuously; When setting clock/timer, press more than 1s, clock/timer value will be increased continuously; When setting vacation days, press more than 1s, day value will be increased continuously; <p>On querying, check items will page up by pressing it.</p> |
| ④ | | <p>Checking function</p> <ol style="list-style-type: none"> In the main interface, press and hold the search key for 1 second to enter the spot check function, and use the up and down keys to switch the spot check channel, and the attribute value of the channel will be displayed when switching to the channel, and the specific channel can be found in the function book. After 30 seconds from the last operation of the up and down keys, or by pressing the return key or the on/off key, you can directly exit the engineering mode; Query mode can be entered in both power-on and power-off state. |
| ⑤ | | <p>Engineering Mode</p> <ol style="list-style-type: none"> In the main interface, press and hold the copy key for 3 seconds to enter the engineering mode; use the up and down keys to switch the inspection channel, and the attribute value of the channel will be displayed when switching to the channel. By up and down key, you can modify a parameter setting, after setting and adjusting, press confirm key to return to the main interface to make the setting effective (channel 2, 3, 4, 34, 35 will be effective immediately). Press the Return button to return to the previous interface (channel selection interface). After 30 seconds from the last operation of the up and down buttons, or by pressing the return button or the on/off button, you can directly exit the engineering mode. Engineering mode can be accessed in both power-on and power-off state. <p>It is strictly prohibited for the customer to change the parameter settings of other channels in the engineering mode without authorisation to avoid affecting the normal operation of the unit or causing damage to the prototype.</p> <ol style="list-style-type: none"> The current maximum set temperature is 65°C , if you need to use a higher temperature, you can enter the engineering mode 18 channel, raise the set temperature upper limit, set the temperature upper limit to 70°C. If the ventilation function is configured, you can enter the engineering mode 12 channel to select the wind gear, 0 means off, 1 means low wind, 2 means middle wind, and 3 means high wind. When the ventilation function takes effect, the main interface displays "FAN". |
| ⑥ | | <p>Power on/off button</p> <p>Press the button to turn the device on or off.</p> |

| No | Icon | Description |
|----|------|---|
| 7 | | <p>TIMER (Daily setting)</p> <ol style="list-style-type: none"> 1) Press the TIMER button to the day timer icon , press the confirmation button to enter the day timer setting interface, the day timer has a total of 6 time periods, each time period can be set to open the time, close the time, mode, set the temperature of the water; when set the first time period set the temperature of the water, press the confirmation button to enter the next time period of the set; when set the sixth time period set the temperature of the water, press the confirmation button to return to the main interface; during this period, you can press the return button Return to the previous setting or main interface; 2) When setting the on time and off time, press the delete button , the time can be restored to the default value, and displaying (-.-). 3) If there is a conflict between the set time periods, the time period set at the back will be the valid time period, and the time period in front will be the invalid time period; the invalid time period restores the default setting 4) You can enter the daily timer setting in both power-on and power-off state. <p>TIMER (Weekly setting)</p> <ol style="list-style-type: none"> 1) Press the TIMER button to the weekly timer icon , press the confirmation button to enter the weekly timer setting interface, weekly timer a total of 7 days, there are 6 time slots can be set each day, each time slot can be set to open the time, close the time, the mode, set the water temperature; when the first time slot set the water temperature, press the confirmation button to enter the next time slot settings; when the sixth time slot set the temperature, press the confirmation button to return to weekly After setting the water temperature for the 6th period, press the confirmation key to return to the selection of week; during this period, you can press the return key to return to the previous level of setting or the main interface; 2) When setting the on time and off time, press the delete button to restore the time, mode and set water temperature to the default value, and displaying (-.-). 3) If you adjust the timing time again after the setting is completed, then all the settings after the adjustment time period will be canceled. For example, if you adjust the timer on for time period 2, the timer off for time period 2, and the settings for time periods 3, 4, 5, and 6 will all be canceled to (-:---) after adjustment. Mode and setting water temperature become default values (Energy saving mode, 60°C) 4) In the weekly timer setting, in the weekly selection, use the copy button , you can locate the setting of a certain day to the base day, select other days, press the copy button to change the status of the day, the fast flashing is selected, the slow flashing is unselected, and after pressing on the confirmation button, you can copy the setting of the base day to the selected day; 5) You can enter the weekly timer setting in both power-on and power-off state. |
| 8 | | <p>CONFIRM/UNLOCK</p> <p>If screen and buttons are unlocked, press it to upload setting parameters after setting any parameter.</p> |

5.3 Combination button

Table. 5-3

| No. | Icon | Description |
|-----|--|---|
| | <p>Setting the date and clock</p> | <ol style="list-style-type: none"> 1) In the main interface, press and hold the timer button for 3 seconds to enter the date setting, press the up/down button to select the date, press the confirmation button to enter the clock setting, press the up/down button to modify the time, and press and hold to accelerate the increase/decrease of the time. After setting the clock, press the confirm button to return to the main interface to complete the setting of date and time. (2) After 30 seconds from the last operation of the up/down button or pressing the return button or the power on/off button, you can directly exit the date and time setting; 3) Setting can be done in both power-on and power-off state. |
| | <p>connecting the wireless function</p> <p>Press for 3 sec</p> | <ol style="list-style-type: none"> 1) In the main interface, long press the on/off key for 3 seconds to enter the AP wireless network mode, there will be a wireless icon in the upper right corner of the line controller. At this time, enter the APP, select the category of air water heater, choose the correct model, and then network according to the APP prompts, and after the network is completed, the wireless icon will be always on; (2) Wireless matching can last up to 8 minutes, after 8 minutes, if the matching is not successful, the wireless icon will go out; 3) Long press the delete button for 8 seconds in the main interface to reset the wireless function; 4) It can be set in both power on and power off state. <p>NOTE: Please check the 5.4 Using the SmartHome App for details.</p> |
| | <p>Child lock function</p> <p>Press for 2 sec</p> | <ol style="list-style-type: none"> 1) In the main interface, long press the key combination for 2 seconds to enter the child lock state; (2) In the state of child lock, long press the key combination again for 2 seconds to release the child lock state; 3) In the locked state, there will be an icon next to the water temperature display. |

5.4 Use Your Appliance with the NetHome Plus App



NOTE

- ⚠️ Ensure that your mobile phone is connected to the home wireless network, the 2.4GHz band wireless signal is enabled on your wireless router and you know the network password.
- ⚠️ Turn on Bluetooth on your phone and the device must also be powered up.

① Download NetHome Plus App

CAUTION: The following QR code is only available for downloading App. It is totally different with the QR code packed with unit.

Android Phone users: scan Android QR code or go to google play, search “Nethome Plus” App and download it.

IOS users: scan IOS QR code or go to APP Store, search “Nethome Plus” app and download it.



Android



IOS

② Register or Login account

Open the App and create a user account, if you already have one, just log in.

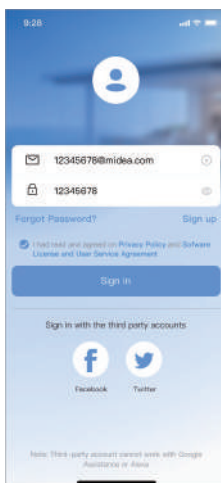

③ Add your appliance

Tap the "+" icon to add home appliance to your NetHome Plus account.

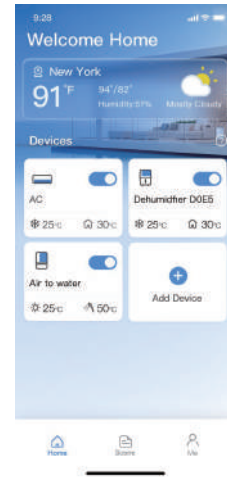

④ Choose Air Source Heat Pump Water Heater.

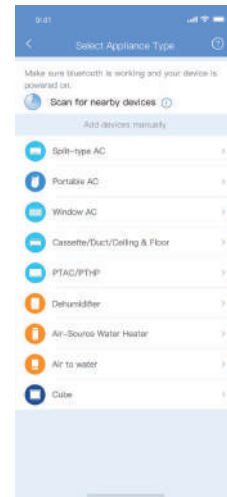

⑤ Connected to the network.

Follow the instructions in the app to set up the Wireless connection.

If the network connection fails, please refer to the App tips for operation.

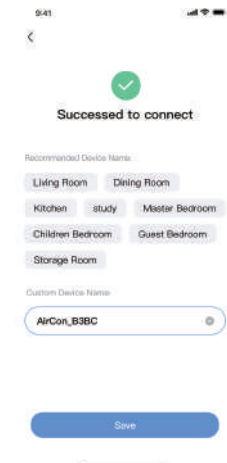

5.4.1 Compliance

We, hereby declare that this device is in compliance with the relevant provisions of RE Directive 2014/53/EU. A copy of the full DoC is attached(Europen Union products only).

Wireless module models:

EU-SK110, US-SK110:

FCC ID: 2ADQOMDNA23

IC: 12575A-MDNA23

BLE:2402-2480MHz,TX Power:< 10dBm

Wi-Fi:2400-2483.5MHz,TX Power:< 20dBm

This device complies with Part 15 of the FCC Rules and it contains licence exempt transmitter(s) / receiver(s) that comply with Innovation, Science and Economic Development Canada's licence-exempt RSS(s). Operation is subject to the following two conditions:

- (1) This device may not cause harmful interference;
- (2) His device must acceptany interference, including interference that may cause undesired operation of the device.

Only operate the device in accordance with the instructions supplied.

Changes or modifications to this unit not expressly approved by the party responsible for compliance could void the user's authority to operate the equipment.

This device complies with FCC radiation exposure limits set forth for an uncontrolled environment. In order to avoid the possibility of exceeding the FCC radio frequency exposure limits, human proximity to the antenna shall not be less than 20cm (8 inches) during normal operation.

In Canada:

CAN ICES-3(B)/NMB-3(B)

Le présent appareil est conforme aux CNR Innovation, Sciences et Développement économique Canada applicables aux appareils radio exempts de licence.

L'exploitation est autorisée aux deux conditions suivantes: (1) il ne doit pas produire de brouillage et (2) l' utilisateur du dispositif doit être prêt à accepter tout brouillage radioélectrique reçu, même si ce brouillage est susceptible de compromettre le fomctionnement du dispositif.

Cet émetteur ne doit pas être Co-placé ou ne fonctionnant en même temps qu'aucune autre antenne ou émetteur. Cet équipement devrait être installé et actionné avec une distance minimum de 20 millimètres entre le radiateur et votre corps.





NOTE

This equipment has been tested and found to comply with the limits for a Class B digital device, pursuant to part 15 of the FCC Rules. These limits are designed to provide reasonable protection against harmful interference in a residential installation. This equipment generates, uses and can radiate radio frequency energy and, if not installed and used in accordance with the instructions, may cause harmful interference to radio communications. However, there is no guarantee that interference will not occur in a particular installation. If this equipment does cause harmful interference to radio or television reception, which can be determined by turning the equipment off and on, the user is encouraged to try to correct the interference by one or more of the following measures:

5.5 Auto-restart

If electricity power failed, unit can memorize all setting parameters, unit will be back to the previous setting when power recover.

5.6 Button Auto Lock

When there is no operation of button for 1 minute, button will be locked except Unlock button  +  for 2s, unlock buttons.

5.7 Screen Auto Lock

If there is no operation of button for 60s, screen will be locked(extinguished) except for error code and alarm icon.Press any button will unlock the screen(lighten).

Enter engineering mode 35 channel enable this function.

6. TROUBLE SHOOTING

6.1 Non-error tips

Q: Why compressor can't start immediately after setting?

A: Unit will wait for 3 min to balance the pressure of system before start compressor again, it's a self protection logic of unit.

Q: Why sometimes the temperature shown on the display panel decreased while unit is running?

A: When the upper tank temperature is much higher than the bottom part, upper part hot water will be mixed by the bottom cold water which is continually flow from inlet tap water so that will decrease the upper part temperature.

Q: Why sometimes the temperature shown on the display decreased but unit still keep closed?

A: to avoid unit ON/OFF frequently, unit will activate heat source only when bottom tank temperature is lower than setting temperature.

Q: Why sometimes the temperature shown on the display will decreased dramatically?

A: Because tank is pressure-bearable type, if there is massive hot demand, hot water will quickly tapped out from upper part of tank as well as cold water will quickly tapped into bottom part of tank, if the cold water surface emerge the upper temperature sensor, temperature shown on the display will decreased dramatically.

Q: Why sometimes the temperature shown on the display is decreased a lot, but there is still a mount of hot water can be tapped?

A: Because the upper water sensor is located on the upper 1/4 tank, when tapping hot water out, it means there is at least 1/4 tank of hot water available.

Q: Why sometimes unit shows "EHLA" on display ?

A: When the unit does not have electric heating function, the heat pump available running ambient air inlet range is -7-43°C, if ambient air inlet temperature is out of range, system will show above-mentioned signal to let user notice it.

Q: Why sometimes the buttons are unavailable?

A: if there is no operation on panel for 60s, unit will lock the panel, shows "🔒", to unlock the panel, please press the "🔒"+ "🔑" button for 2 seconds.

Q: Why sometimes there is some water flowed from drainage pipe of safety valve?

A: Because the tank is pressure-bearable one, when water is heated inside the tank, water will expand, so the pressure inside of tank will increase, if pressure goes up more than 1.0MPa, safety valve will activate to relief the pressure and hot water drop will be discharged correspondingly. If water drop is continually discharged from safety valve drainage pipe, it is abnormal, please contact qualified staff to repair.

6.2 Something about self-protection of unit

- 1) When the self-protection happens, the system will be stopped and start self-check, and restart when the protection resolved.
- 2) When the self-protection happens, the 🔔 will flash and error code will be shown at water temperature indicator. But the 🔔 and error code does not disappear until protection resolved.
- 3) The evaporator is covered with too much dust; Incorrect power supply(exceeding the range of 220-240V).

6.3 When Error happened

- 1) If some normal errors happen, unit will automatically shift to E-heater for emergent SHW supply, please contact qualified staff to repair.
- 2) If some sever error happen, unit will not start, please contact qualified staff to repair.

6.4 Error phenomenon shooting

Table. 6-1

| Error phenomenon | Possible reason | solution |
|---|--|--|
| Cold water tapped out and display screen extinguished | <ol style="list-style-type: none"> 1. Bad connection between power supply plug and socket; 2. Setting water temperature too low; 3. Temp. sensor broken; PCB of indicator broken. | <ol style="list-style-type: none"> 1. Plug in; 2. Setting water temp. higher; 3. Contact service center. |
| No hot water tapped out | <ol style="list-style-type: none"> 1. Public water supply ceased; 2. Cold water inlet pressure too low (<0.15 MPa); 3. Cold water inlet valve closed. | <ol style="list-style-type: none"> 1. Waiting for public water supply recover; 2. Waiting for inlet water pressure increase; 3. Open water inlet valve. |
| Water leakage | Hydraulic pipeline joints are not sealed well. | Check and reseal all joints. |

6.5 Error code shooting table

Table. 6-2

| Display | Malfunction Description | Corrective action |
|---------|--|--|
| EH0b | Tank and LCD panel communication error. | Maybe the connection between LCD panel and PCB has released or PCB has been broken. |
| EH00 | Machine working parameters are abnormal. | Contact a qualified person to service the unit. |
| EH03 | Dc fan fault. | Maybe the connection between fan and PCB has released or fan has been broken. Contact a qualified person to service the unit. |
| PH15 | Electric leakage error. If PCB current_induction_circuit check the current difference between L,N >14mA, system consider it as"electric leakage error". | Maybe some wires have been broken or bad wire connection. Contact a qualified person to service the unit. |
| EC54 | Compressor discharge temperature sensor TP error. | Maybe the connection between sensor and PCB has released or sensor has been broken. Contact a qualified person to service the unit. |
| EH5H | Compressor suction temperature sensor TH error. | Maybe the connection between sensor and PCB has released or sensor has been broken. Contact a qualified person to service the unit. |
| EC53 | Ambient temperature sensor T4 error. | Maybe the connection between sensor and PCB has released or sensor has been broken. Contact a qualified person to service the unit. |
| EC52 | Evaporator temperature sensor T3 error. | Maybe the connection between sensor and PCB has released or sensor has been broken. Contact a qualified person to service the unit. |
| EH5L | Error of sensor T5L(lower water temperature sensor) | Maybe the connection between sensor and PCB has released or sensor has been broken. Contact a qualified person to service the unit. |
| EH5U | Error of sensor T5U(upper water temperature sensor) | Maybe the connection between sensor and PCB has released or sensor has been broken. Contact a qualified person to service the unit. |
| EHLA | When the ambient temperature T4 is out of the compressor operating range, the compressor stops, and EHLA is displayed until T4 returns to the normal range. Only works on units without electric heaters. Devices with electric heaters will never display "EHLA". | It is normal, and no necessary to repair. |
| EH5d | electric heater open-circuit error | Maybe the electric heater has been broken or bad wire connection after repair. |
| EHHP | Heat pump system fault. When PH20, PH21, PC30, PC06 any protection appears 3 times or the protection lasts 1 hour. | The compressor works abnormally. Contact a qualified person to service the unit. |
| PHdH | Dry burning protection. | Ensure that there is water in the water tank before heating. |
| PH20 | Compressor abnormally stopped protection The discharge temperature is not so higher than evaporator temperature after compressor running a term. | Maybe because of compressor broken or bad connection between PCB and compressor. Contact a qualified person to service the unit. |
| PH21 | The working current of the compressor is too large. | Maybe because of compressor broken, system blocked, air or water or more refrigerant in system(after repair), water temperature sensor malfunction, ect. Contact a qualified person to service the unit. |
| PH24 | Frost protection.T5L< 4°C and T4 < 7°C | The cold water temperature is too low, which will affect the water tank. The electric heater will work. |
| PC30 | System high pressure protection ≥3.0MPa active; ≤2.4Mpa inactive | Maybe because of system blocked, air or water or more refrigerant in system(after repair), water temperature sensor malfunction, ect. Contact a qualified person to service the unit. |
| PC06 | High TP protection.Tp>110°C, Protection active Tp<90°C, Protection inactive | Maybe because of system blocked, air or water or less refrigerant(leakage) in system(after repair), water temperature sensor malfunction, ect. Contact a qualified person to service the unit. |
| PH9b | Overtemperature protection.The current water temperature exceeds the target temperature by more than 5 °C. | The water temperature sensor is faulty or the current water temperature is too high. In case of burns, contact a qualified person to check. |
| PH91 | Low T3 protection. | If the fault persists, Contact a qualified person to service the unit. |

7. MAINTENANCE



CAUTION

Always Turn off your Air-source Heat Pump Water Heater system and disconnect its power supply before cleaning or maintenance.

7.1 Maintenance

- 1) Check the connection between power supply plug and socket and ground wiring regularly;
- 2) In some cold area (below 0°C), if the system will be stopped for a long time, all the water should be released in case of freezing of inner tank and damage of E-heater.
- 3) It is recommended to clean the inner tank and E-heater every half year to keep an efficient performance. For more details, please contact the supplier or the after-sale service.
- 4) Check the anode rod every half year and change it, if it has been used out. For more details, please contact the supplier or the after-sale service.
- 5) It is recommended to set a lower temperature to decrease the heat release, prevent scale and save energy if the outlet water volume is sufficient.
- 6) Clean the air filter every month in case of any inefficiency on the heating performance.
In terms of the filter set in air inlet directly (namely, air inlet without connect with duct), the method of dismantle the filter is: anti-clockwise unscrew the air inlet ring, take out the filter and clean it completely, finally, remount it to the unit.
- 7) Before shutting the system off for a long time, please:
Shut off the power supply;
Release all the water in water tank and the pipeline and close all the valves;
Check the inner components regularly.
- 8) Reset the safety temperature limiter. For more details, please contact the supplier or the after-sale service.
 - Before resetting the back-up temperature limiter, ensure that the operation has not been interrupted by activating a energy-saving contact ora time schedule.
 - Check whether the safety temperature limiter of the additional electric heating has been set due to overheating (> 85 °C) or if it was triggered by a fault.
 - Loosen the screws on the undercoat.
 - Remove the undercoat.
 - Press the key to reset the safety temperature limiter.

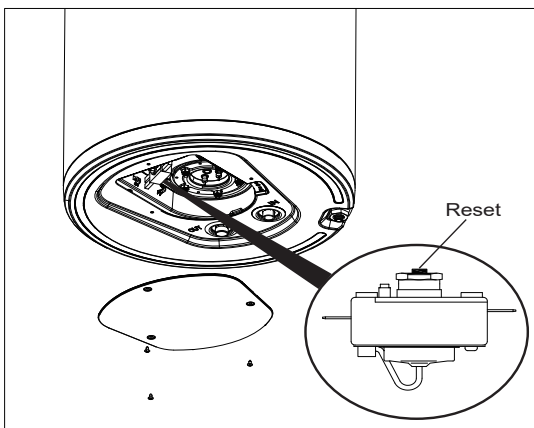
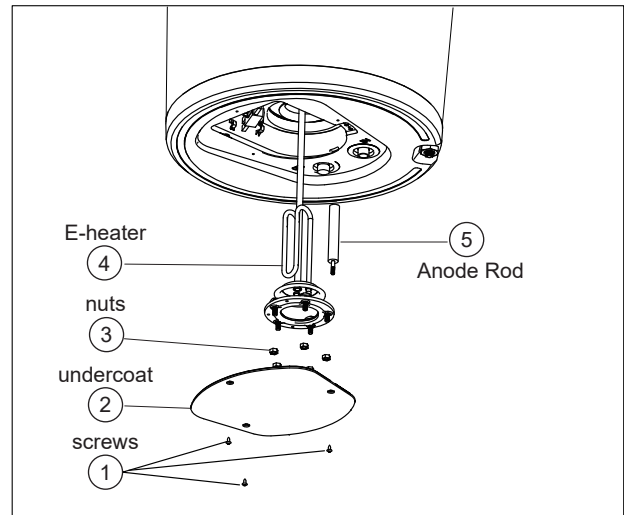

Fig.7-1

WARNING

Installation professionals must disassemble, users are not allowed to disassemble.

- 9) Checking of protective anodes. For more details, please contact the supplier or the after-sale service.



- Empty the product.
- loosen the screws on the undercoat
- Remove the undercoat.
- Remove the cable from the electrical immersion resistance.
- Remove the nuts .
- Extract the group with the electrical resistance to immersion and the anode, the protective anode and the seal.
- Unscrew the protective anode and remove it from the hot water heater.
- Remove the protective anode and check the following point.
Diameter (whole length): > 16 mm uniform wear of the protective anode.
- Check whether there are deposits of limestone on the immersion resistance.
- Check the anode of electrical resistance under immersion.
- If the protective anode is worn out, it shall be replaced by the same procedure as the immersion electric resistance anode.
- Replace the lining.



WARNING

1. Battery must be disposed of properly. Do not short circuit or dispose of in the fire.
2. Keep batteries out of the reach of children.
3. Caution for ingestion.
4. Non-rechargeable batteries are not to be recharged.
5. Exhausted batteries are to be removed from the product.
6. Dispose of the old batteries in the special containers to be found in the sales outlets.
7. Replace the battery must contact the supplier or the after-sale service.

7.2 Recommended regular maintenance table

Table. 7-1

| Checking Item | Checking content | Checking frequency | Action |
|---------------|--------------------|--------------------|------------------------------------|
| 1 | air filter (inlet) | every month | Clean the filter |
| 2 | anode rod | every half year | Replace it if it has been used out |
| 3 | inner tank | every half year | Clean the tank |
| 4 | E-heater | every half year | Clean E-heater |
| 5 | Safety valve | every month | Check for blockage |

For more details, please contact the supplier or the after-sale service.

8. SPECIFICATIONS

Table. 8-1

| | | |
|---|-------------------------|---|
| Model | | WHITE 80 |
| Water-heating cap.(a) | | 950W |
| Rated power/AMPS | | 1950W/9A |
| Power supply | | 220-240V~ 50Hz |
| Operation control | | Auto/Manual startup, error alarm, timer,etc |
| Protection | | Over-load Protector, Temp Controller&Protector, Electric Leakage Protector, etc |
| E-heater power | | 1500W |
| Refrigerant | | R290/0.15kg |
| Water pipeline system | Outlet water temp.(b) | Default 50°C, (38-65°C adjustable) |
| | Water side exchanger | Aluminum microchannel heat exchanger |
| | Inlet pipe Dia. | DN15 |
| | Outlet pipe Dia. | DN15 |
| | Drain pipe Dia. | DN12 |
| | Max. operating pressure | 0.8MPa |
| Exchanger air side | Material | Aluminum fin, inner groove copper tube |
| | Motor power | 34W |
| | Air circulation way | Outlet/inlet vertically, duct connection available |
| Dimension | | Φ500×548×1195mm |
| Water tank cap. | | 78L |
| Net weight | | 57kg |
| Fusible link type | | T5A 250VAC/T16A 250VAC |
| <p>The test conditions:</p> <p>(a). Ambient temperature 15/12°C(DB/WB), Water temperature from 15°C up to 45°C.</p> <p>(b). 70°C(The maximum outlet temperature is set to 65°C by default.)</p> | | |



A2B Accorroni E.G. s.r.l.
Via d'Ancona, 37 - 60027 Osimo (An) - Tel. 071.723991
web site: www.accorroni.it - e-mail: a2b@accorroni.it